

pivot door

Installation instructions

R-QP-GX60/70/80/90/100

R-MS-GX-P

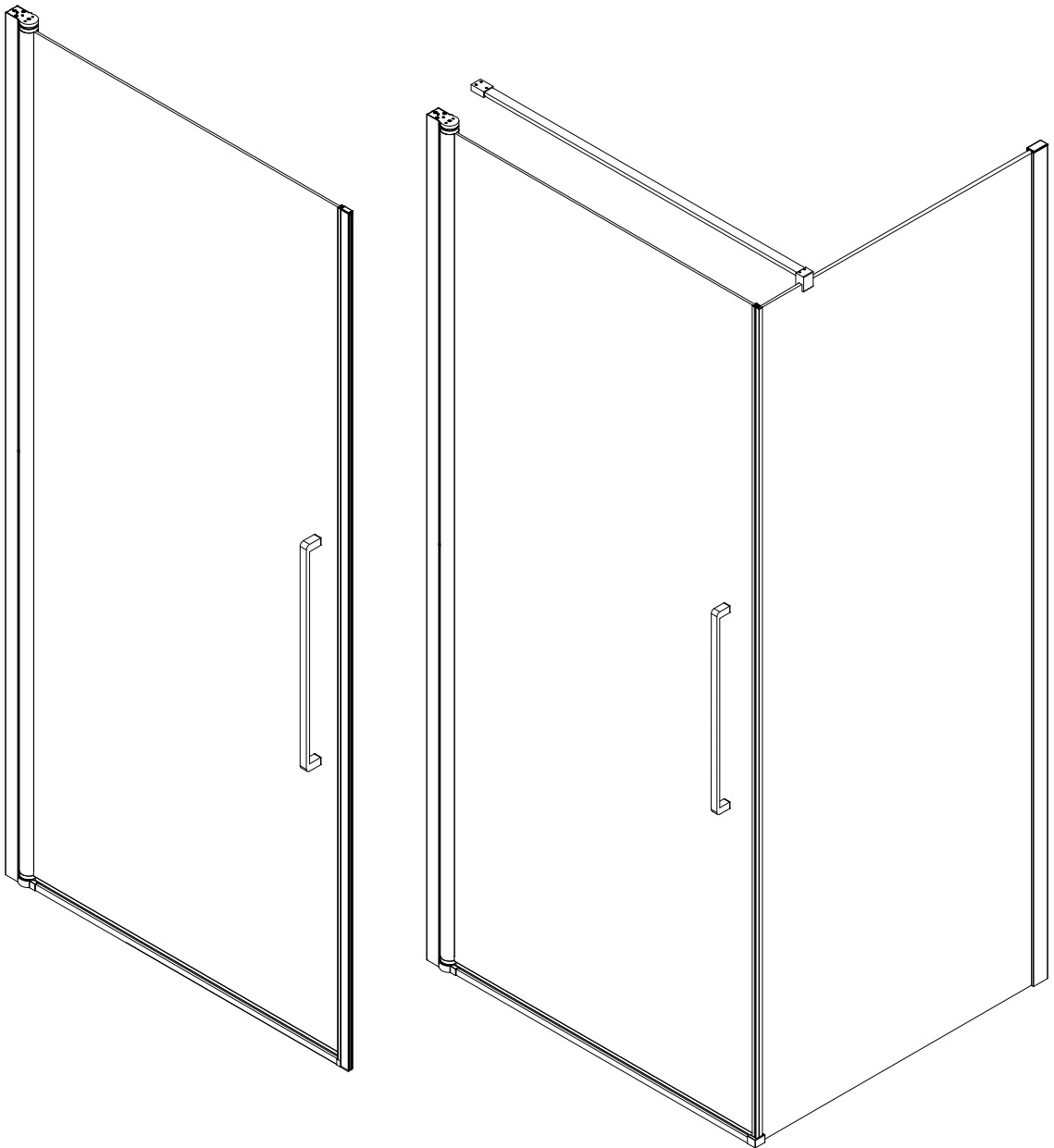

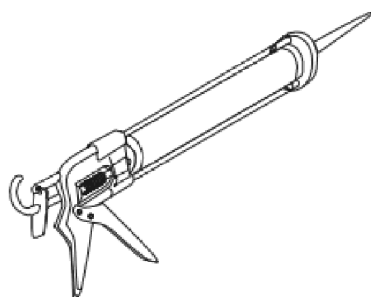

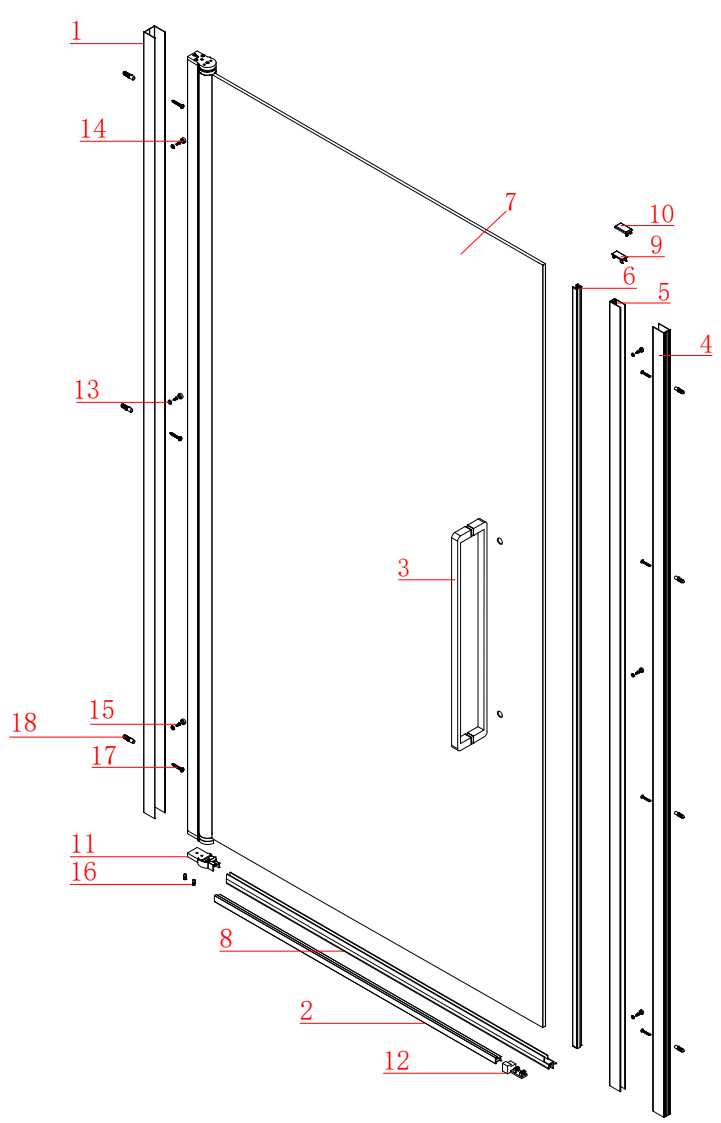

① x 1 	② x 1 	③ x 1 	④ x 1 	⑤ x 1 	⑥ x 1 	⑦ x 1
⑧ x 2 	⑨ x 1 	⑩ x 1 	⑪ x 1 	⑫ x 1 	⑬ x 6 	⑭ x 6
⑮ x 6 	⑯ x 2 	⑰ x 7 	⑱ x 7 	x 1 		



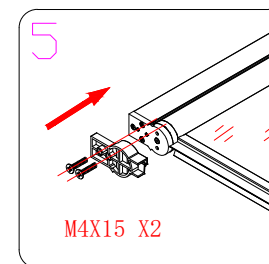
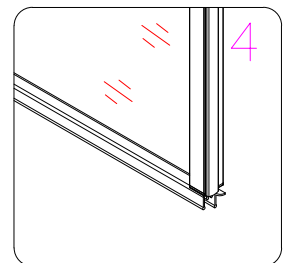
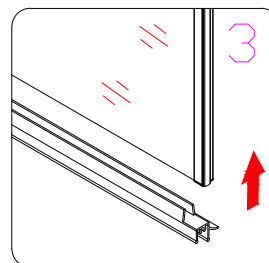
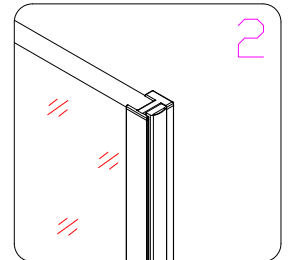
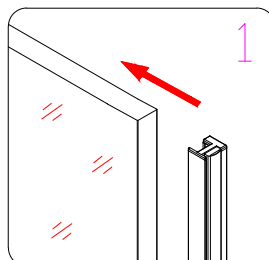
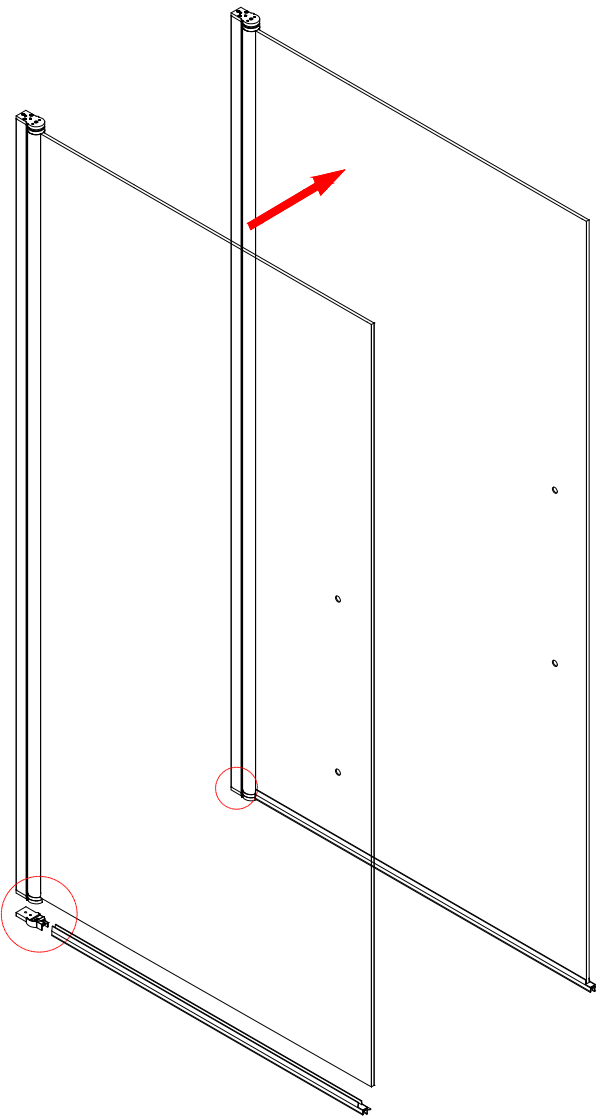
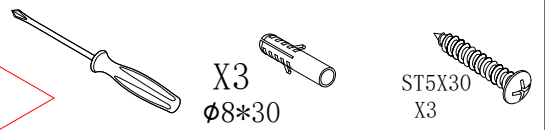
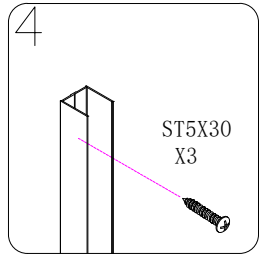
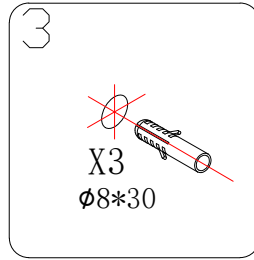
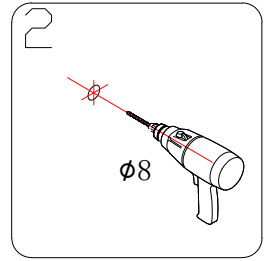
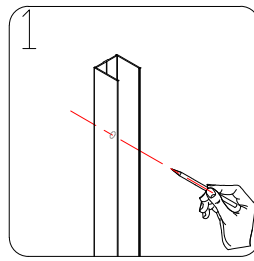
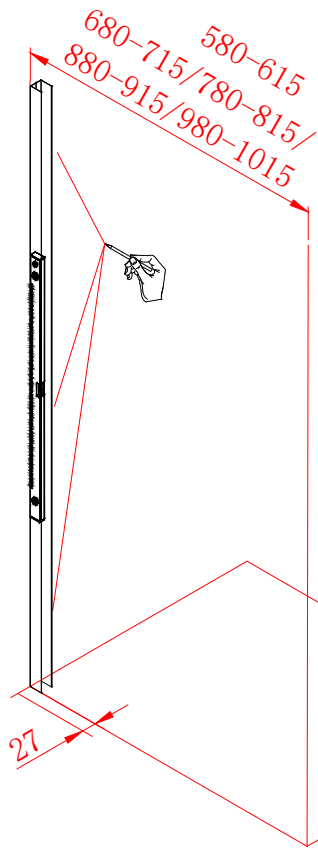

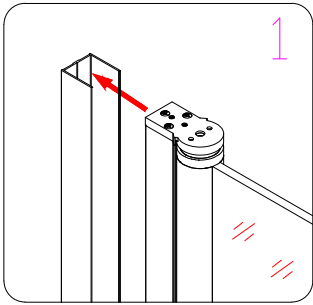

1

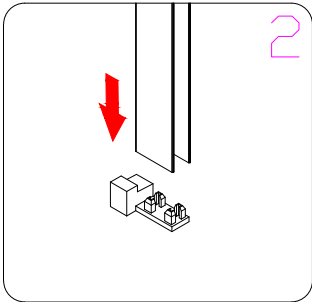

2

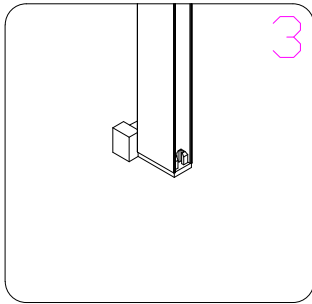

3

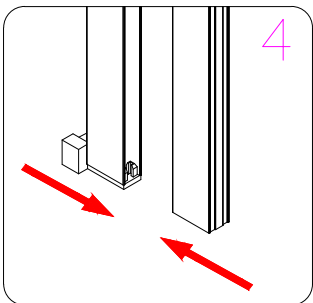

4

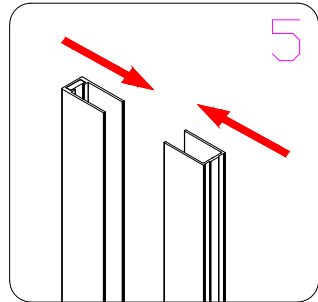

5

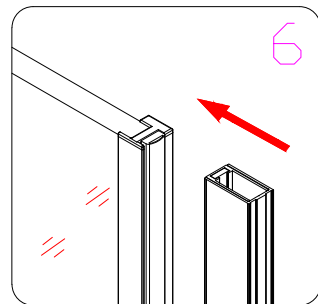

6

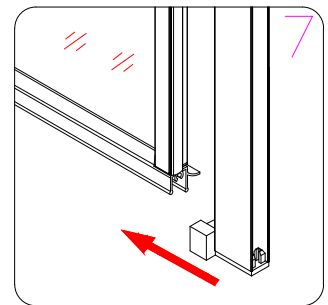

7

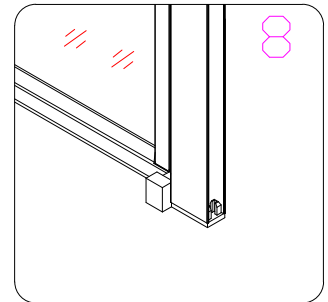

8

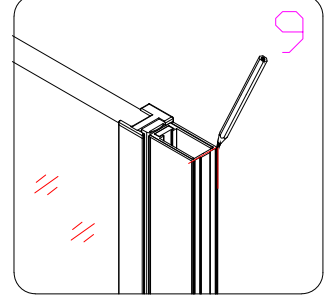

9

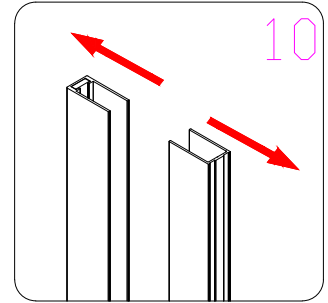

10

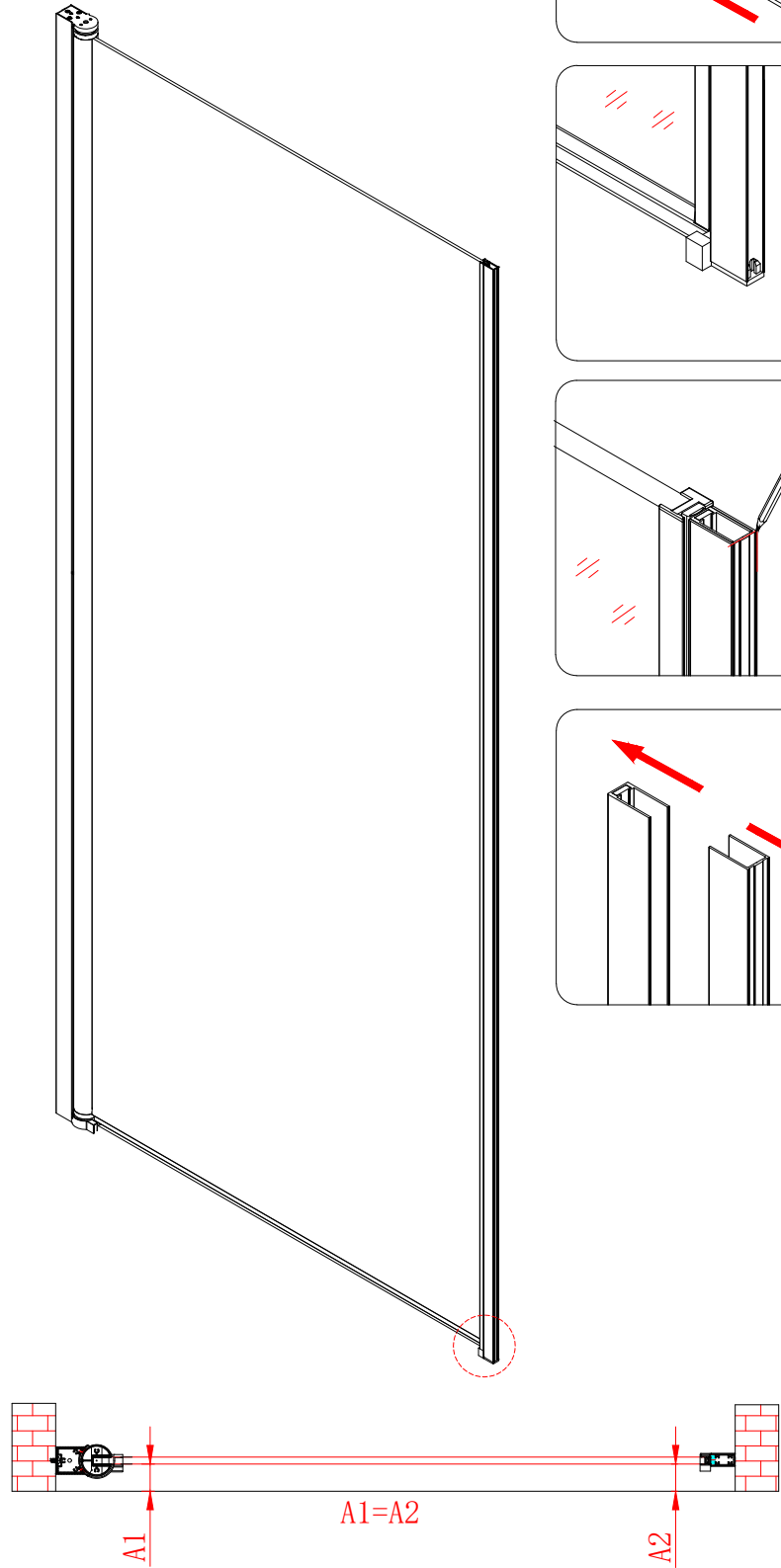

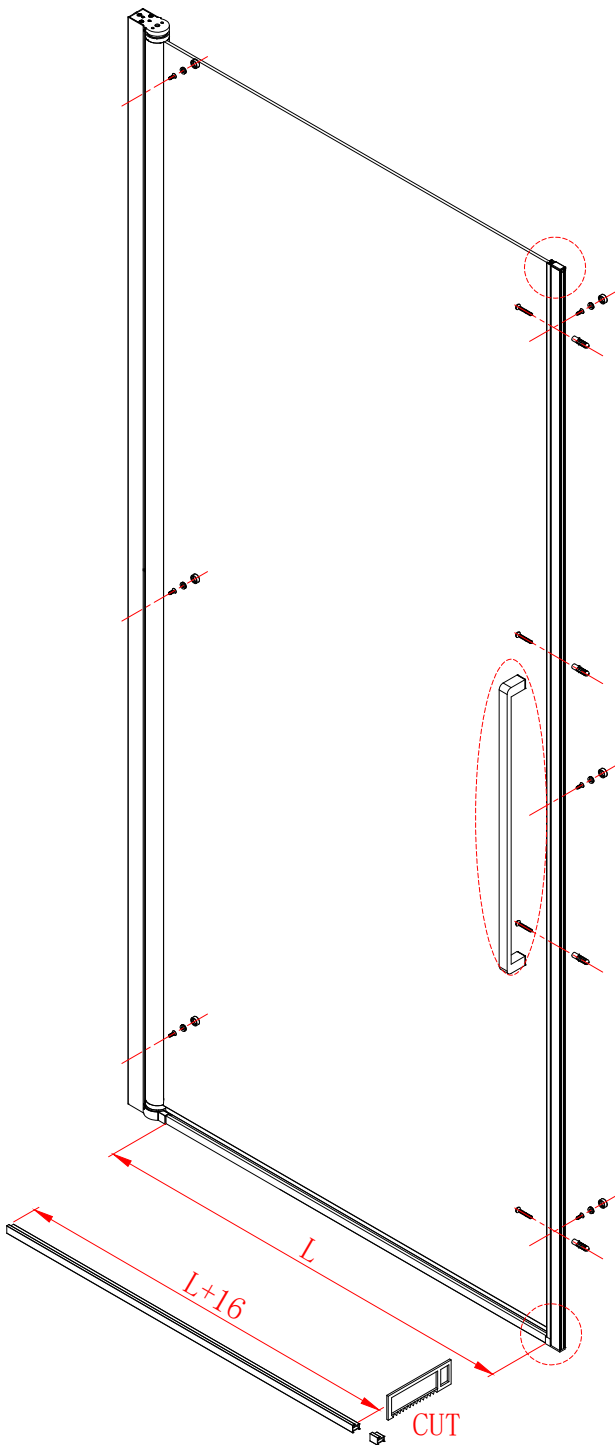
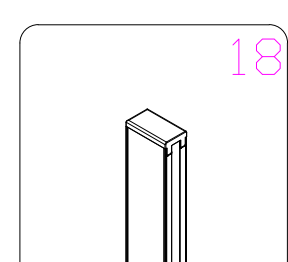
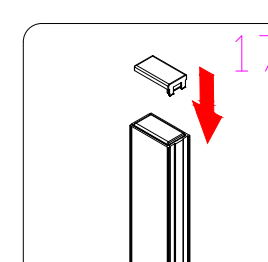
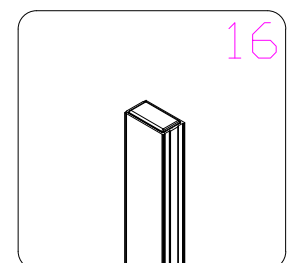
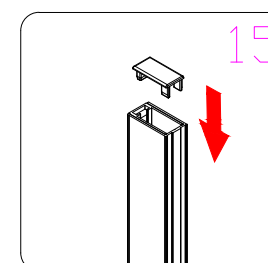
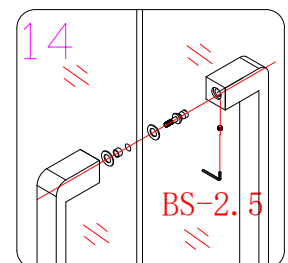
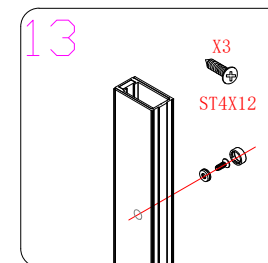
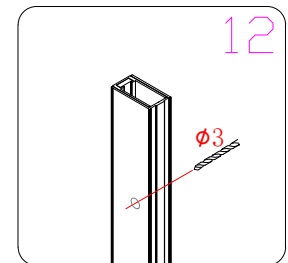
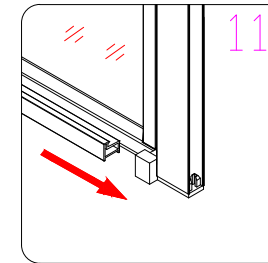
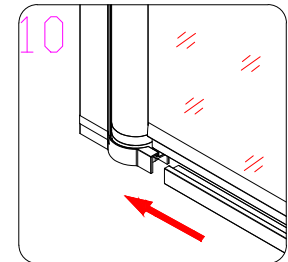
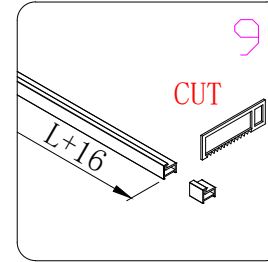
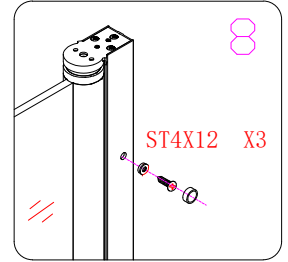
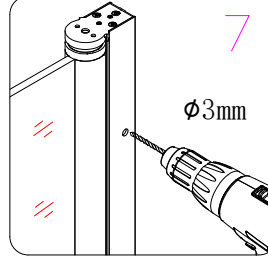
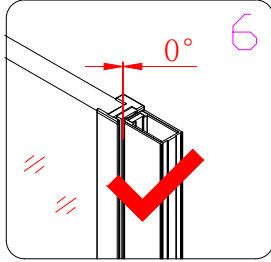
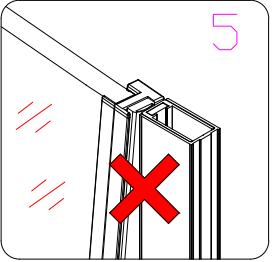
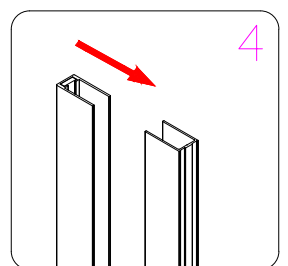
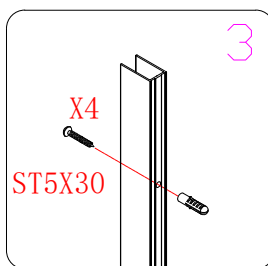
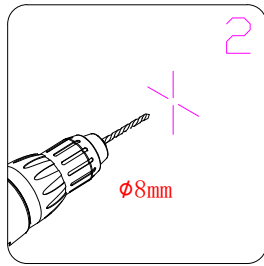
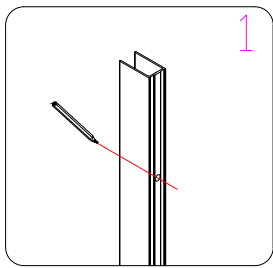



Coated
Glass

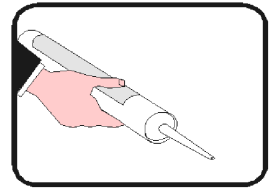
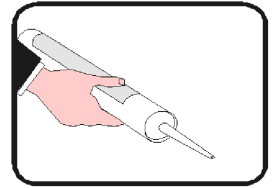
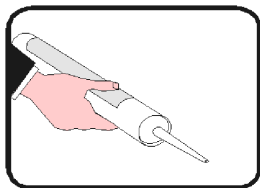
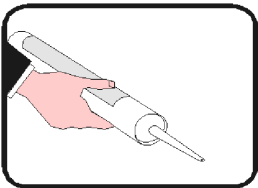
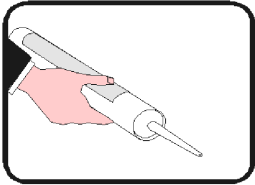

7

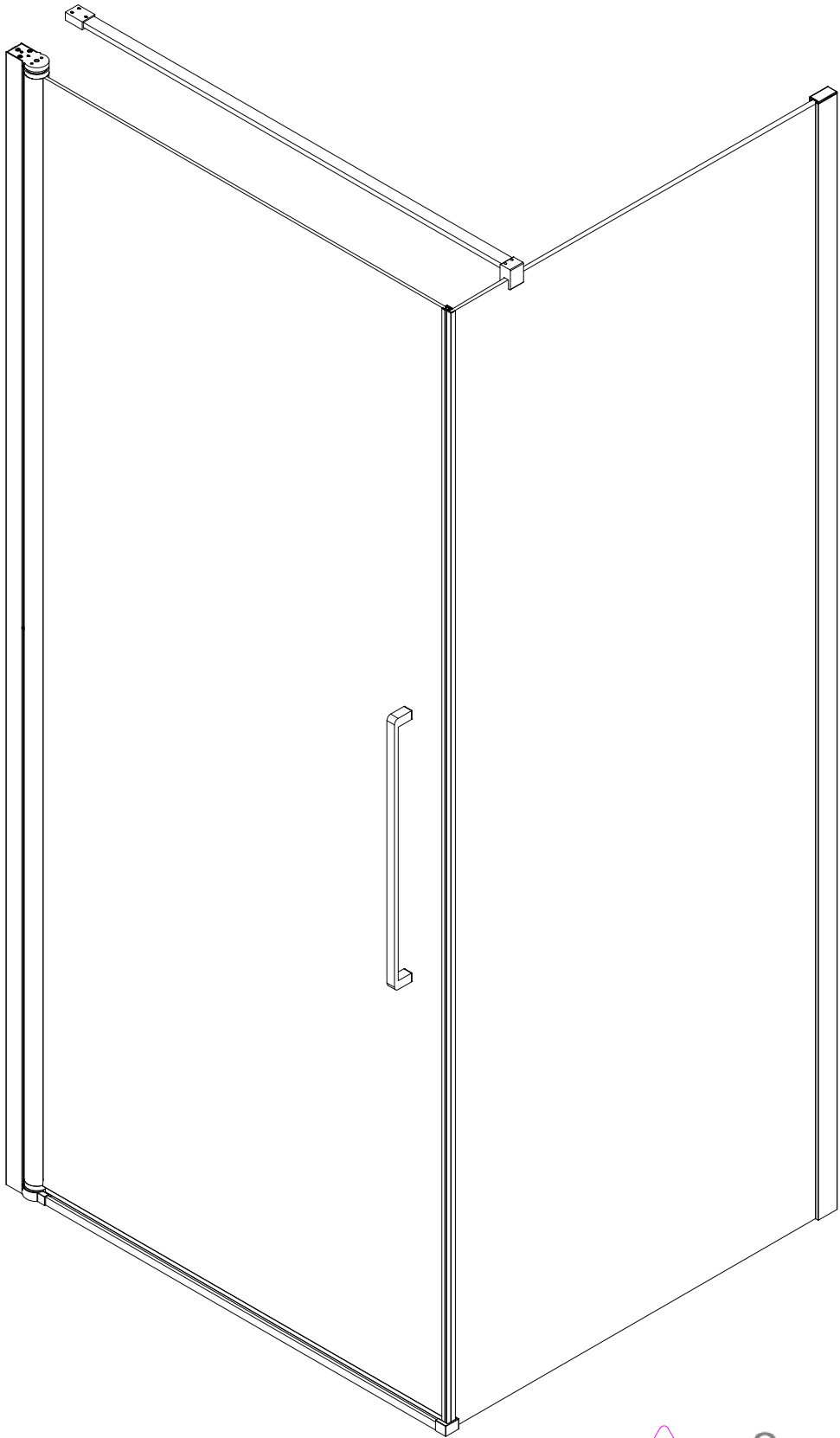

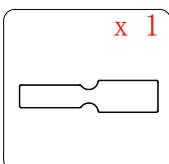
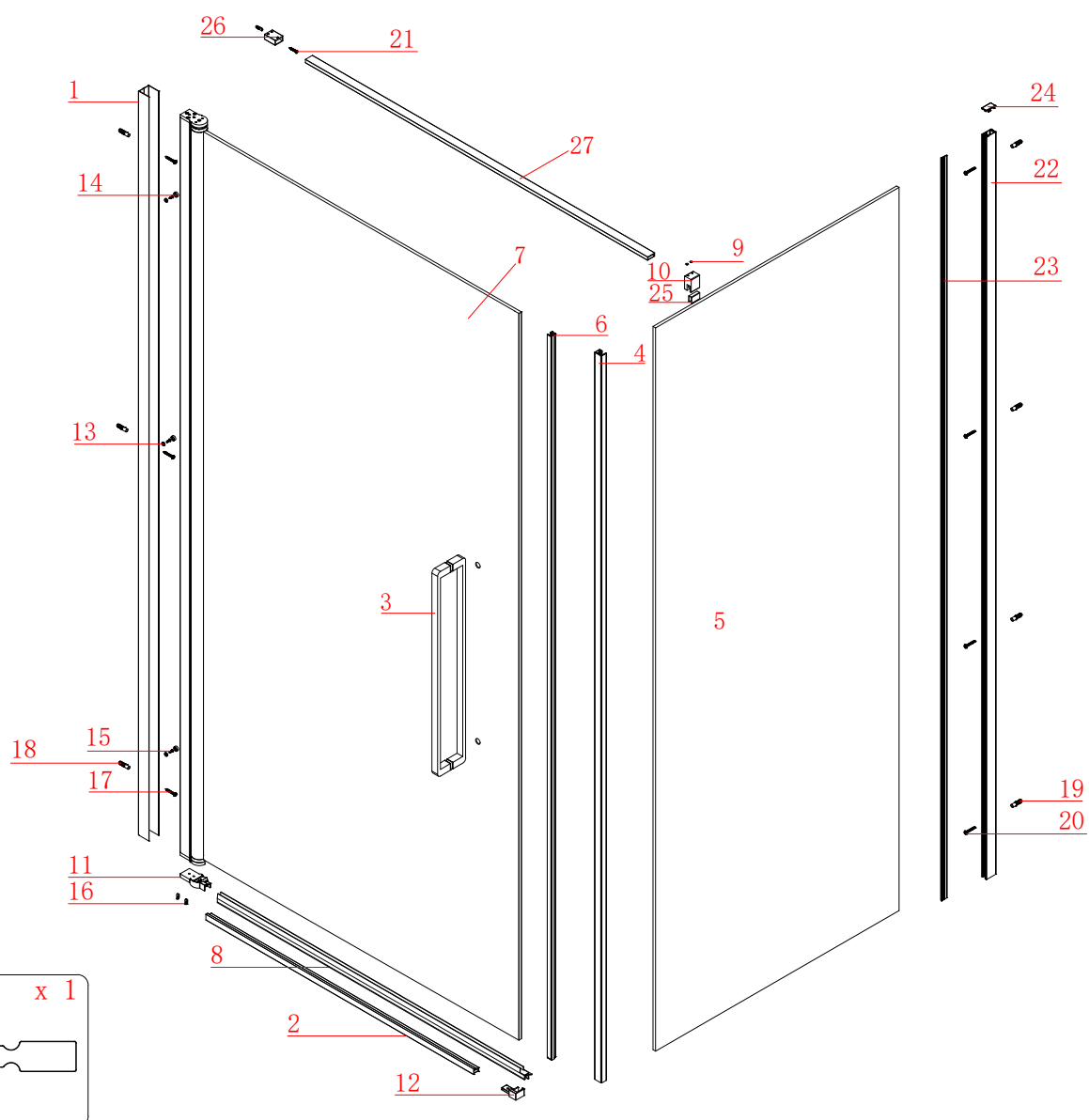

① x 1	② x 1	③ x 1	④ x 1	⑤ x 1	⑥ x 1	⑦ x 1
⑧ x 2	⑨ x 2	⑩ x 1	⑪ x 2	⑫ x 2	⑬ x 3	⑭ x 3
⑮ x 3	⑯ x 2	⑰ x 3	⑱ x 3	⑲ x 4	⑳ x 4	㉑ x 1
㉒ x 1	㉓ x 1	㉔ x 2	㉕ x 1	㉖ x 1	㉗ x 1	㉘ x 2

L&R, L&R, L&R, L&R, ST4X12, M4X15, ST5X30, Ø8X30, Ø6X30, ST4X30, ST5X40, L&R, BS-2.5/4



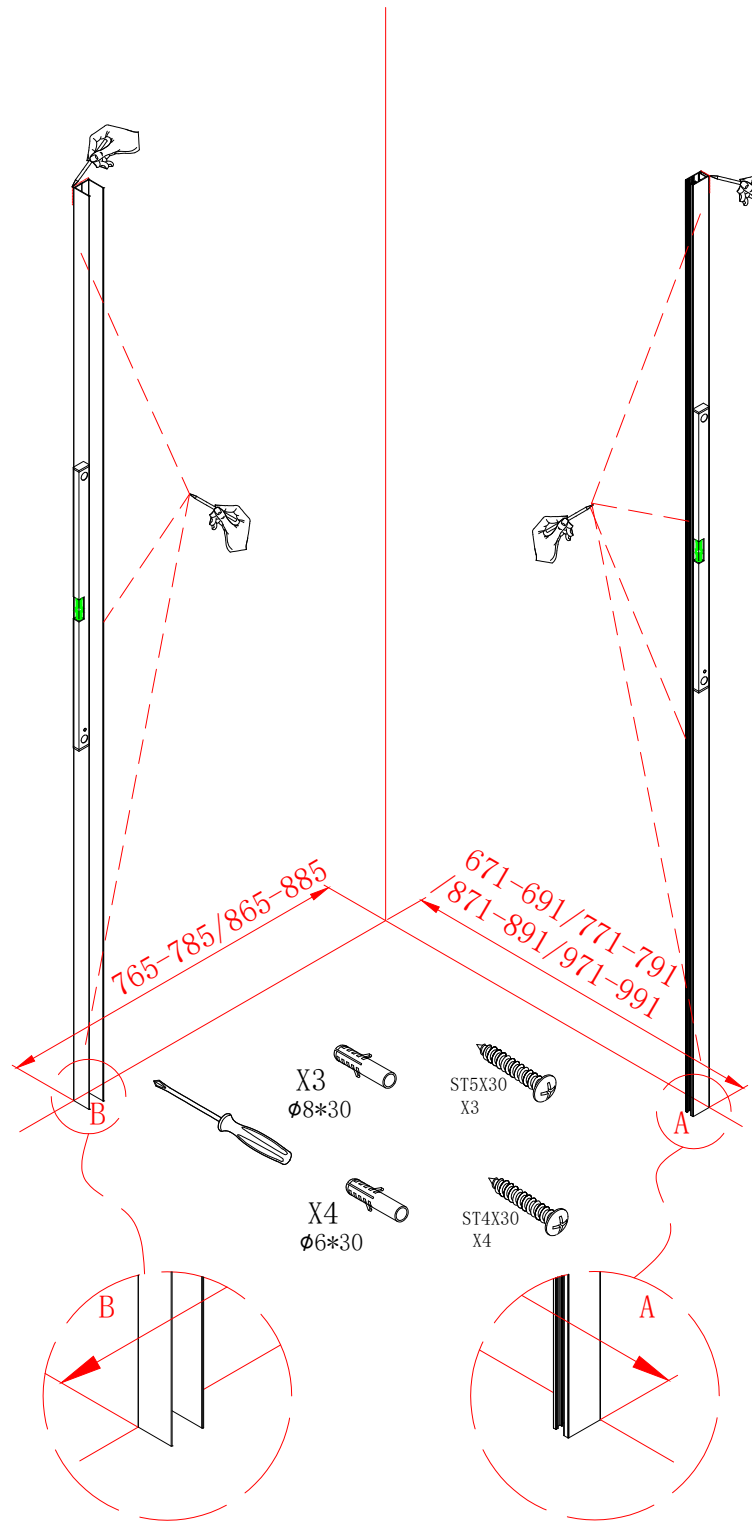
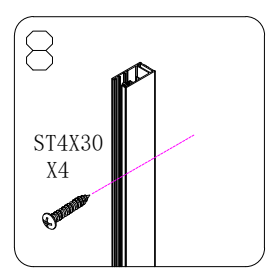
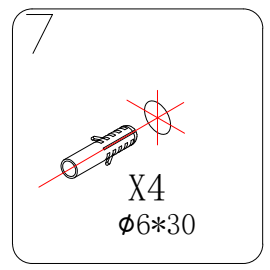
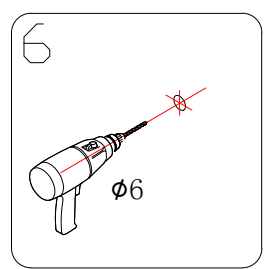
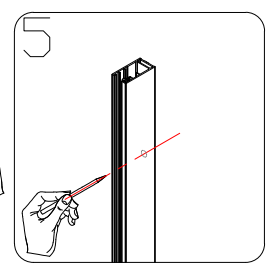
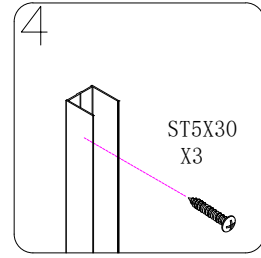
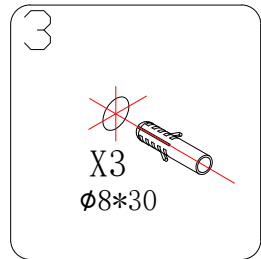
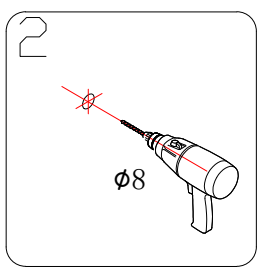
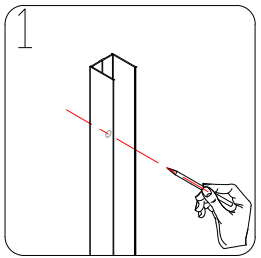

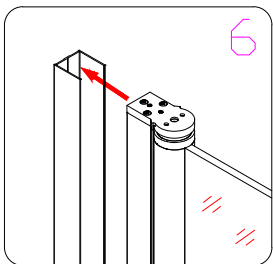
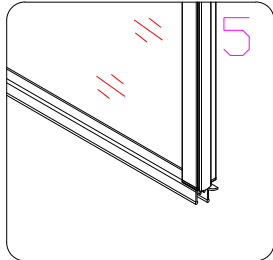
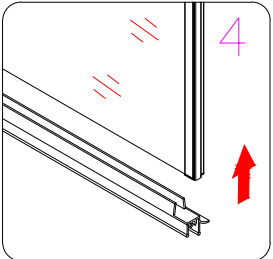
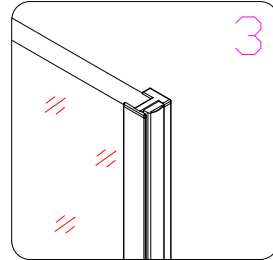
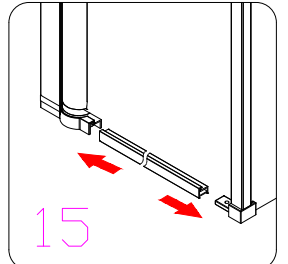
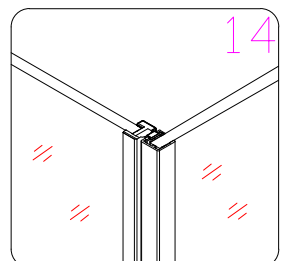
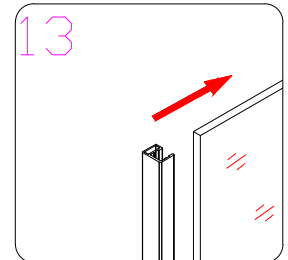
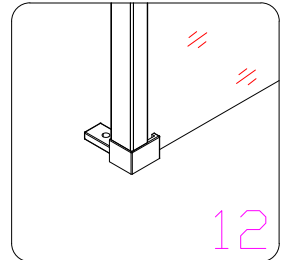
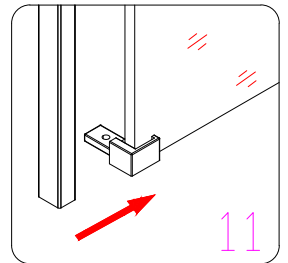
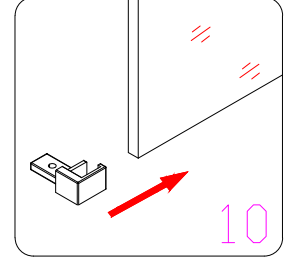
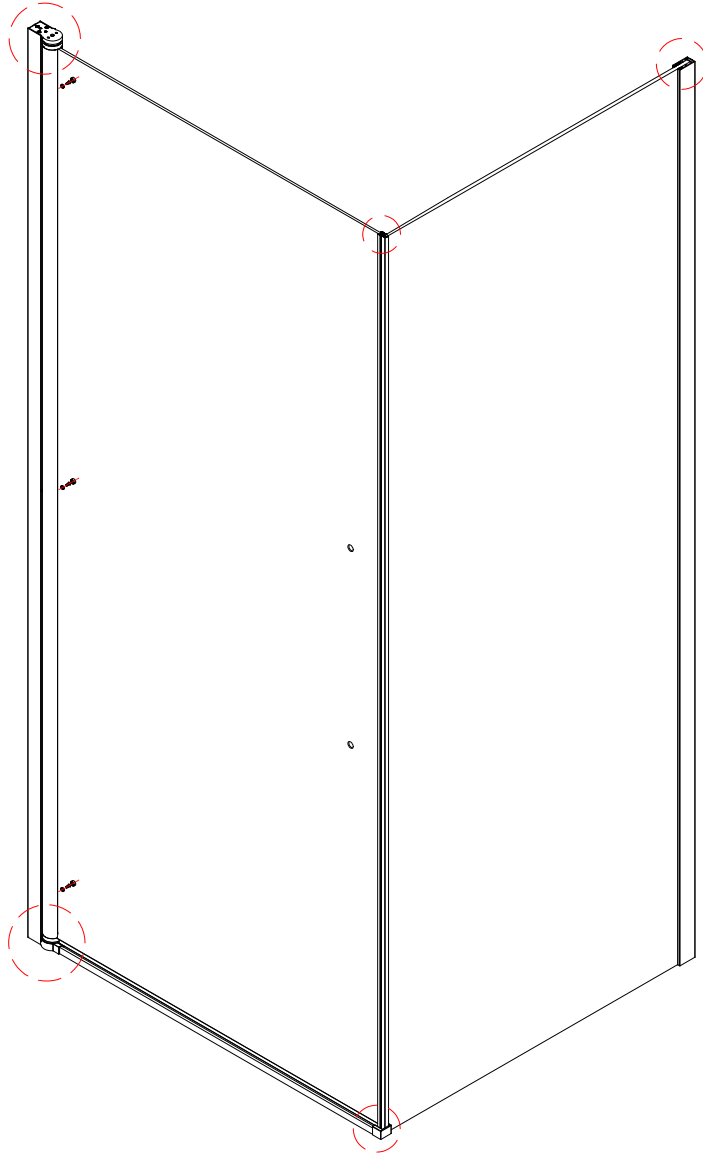
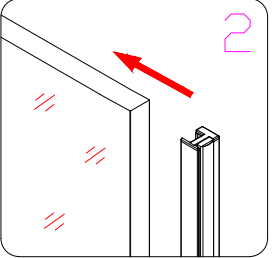
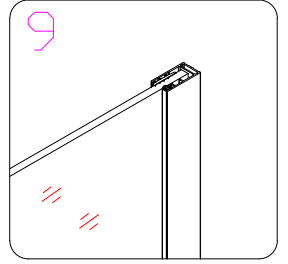
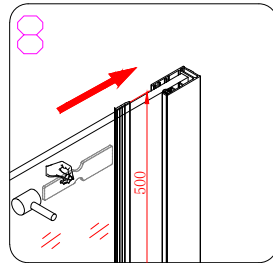
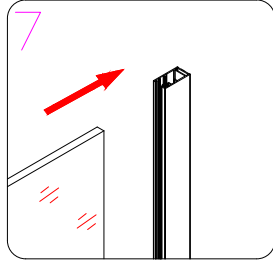
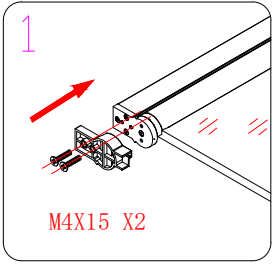

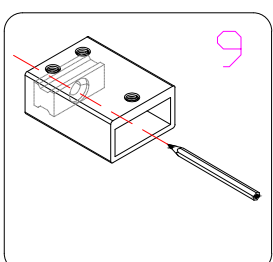
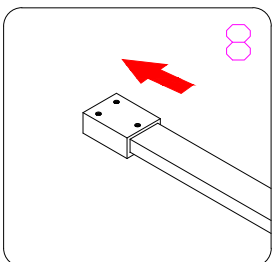
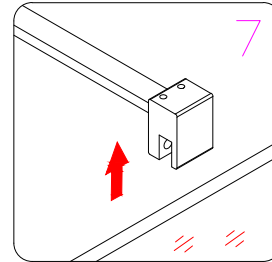
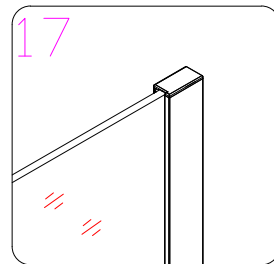
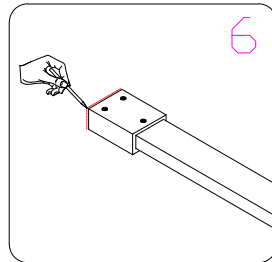
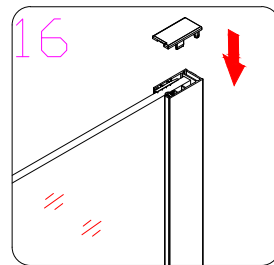
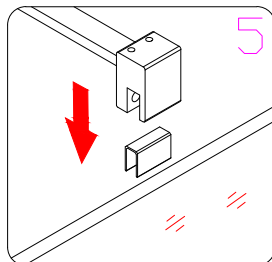
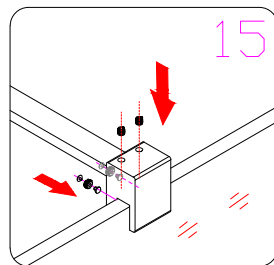
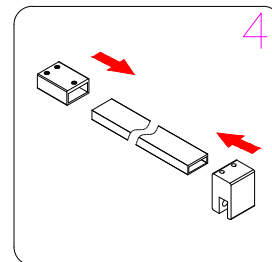
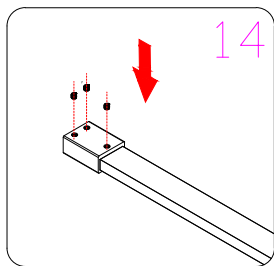
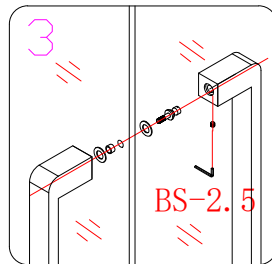
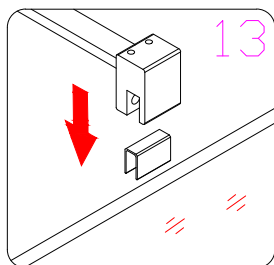
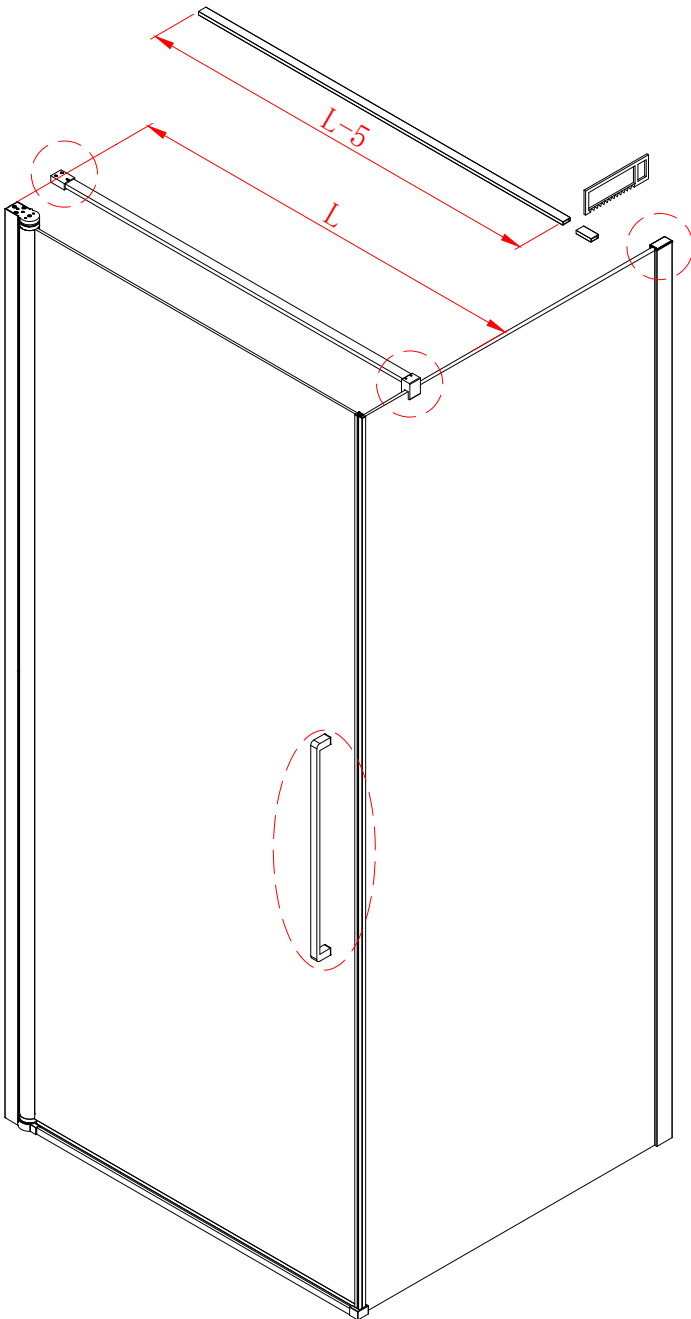
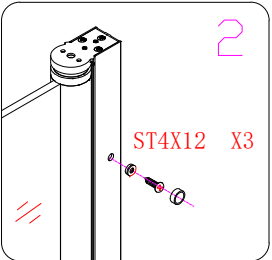
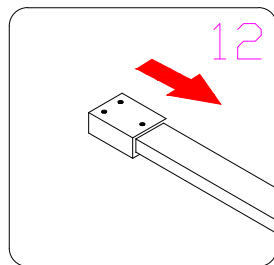
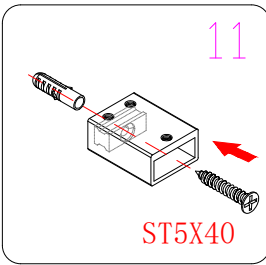
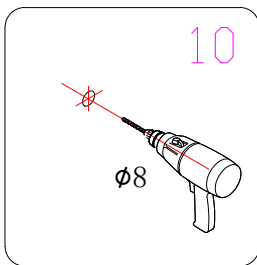
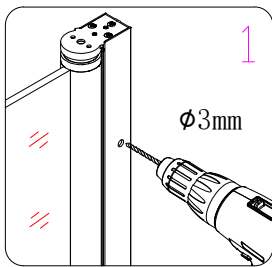



Coated
Glass

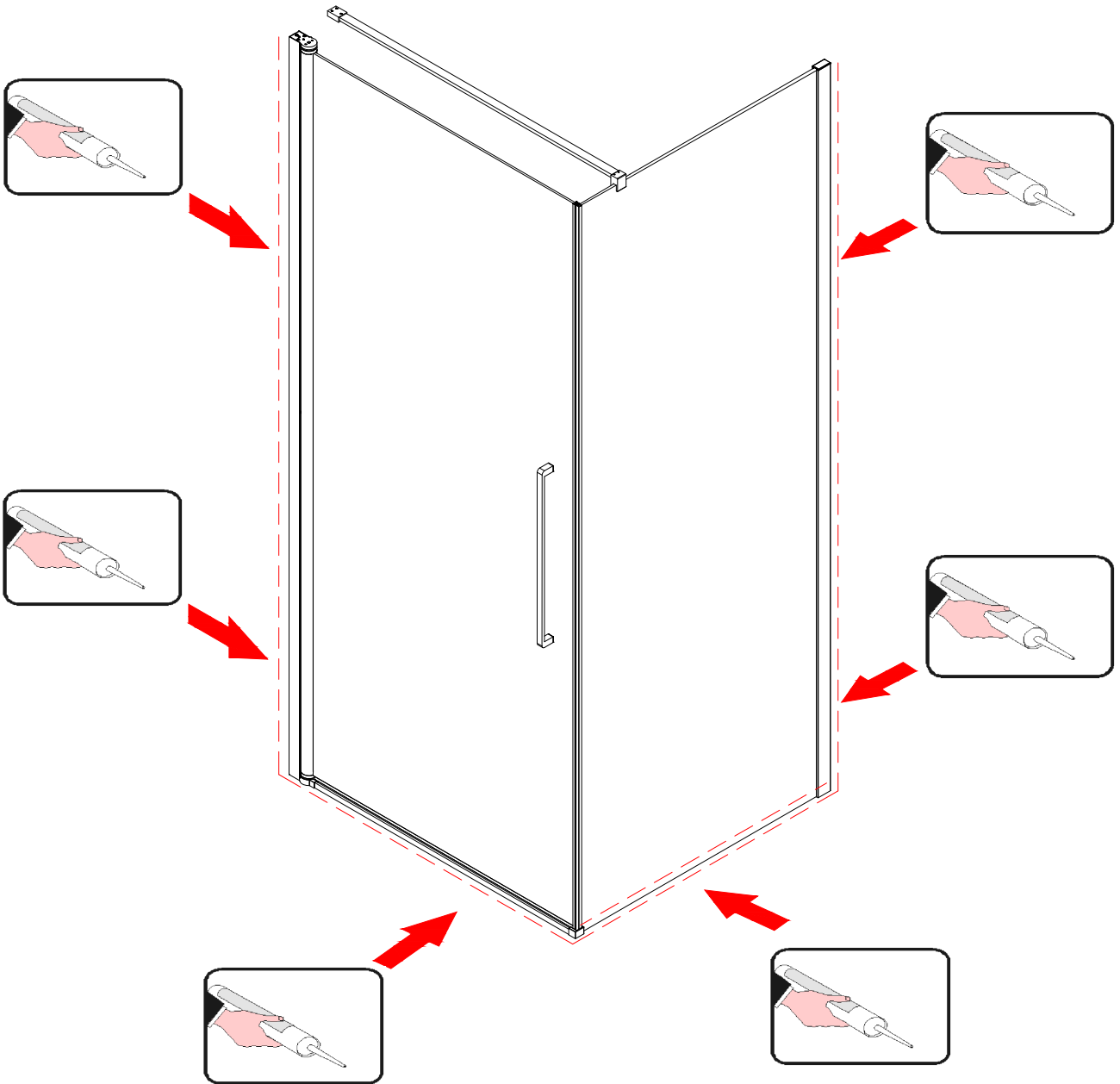



Deutsch

Die nachfolgenden Pflegehinweise wird empfohlen.

Wichtig ist eine regelmäßige Pflege und Reinigung Ihrer Dusche aus Echt Glas. Es ist sinnvoll Rückstände nach jedem Duschen sofort mit klarem kaltem Wasser abzuspülen. Das Abziehen mit einem Glaswischer verhindert das Festsetzen von Kalk. Flecken haben somit keine Chance. Auch die Profile bleiben lange schön, wenn diese mit einem weichen Tuch nach dem Duschen sofort trocken gewischt werden. So wird der Zeit- und Energieaufwand, im Gegensatz zu einer späteren Pflege der Dusche, bereits im Vorfeld enorm gemindert. Zudem wird ein übermäßiger Verbrauch von Putz- und Pflegemitteln auf diese Weise reduziert. Das spart Kosten und schont die Umwelt.

Beim Gebrauch von handelsüblichen Reinigungsmitteln zur Pflege sollten nach Gebrauch mit klarem Wasser komplett abgespült werden, bevor Sie die Dusche trocknen.

Verwenden Sie keinesfalls Scheuermittel, Lösungsmittel und harte scheuernde Schwämme. Denn auch kleinste Beschädigungen und Risse im Glas bieten Kalk und Schmutz einen echten Nährboden, um sich hier festzusetzen. Reinigungsmittel mit einem PH-Wert unter 3 oder über 10 beschädigen Profile, Scharniere, Griffe und Glasbeschichtungen.



Nederlands

De volgende onderhoudstips worden aanbevolen

Het regelmatig onderhouden reinigen zijn van groot belang voor uw douche.

Na het douchen, het materiaal direct afspoelen met koud water en het glas afnemen met een badkamerwisser. Dit voorkomt aanhechting van kalk.

Daarnaast de profielen afdrogen een zachte doek na het douchen. Dus is de tijd en energie, in tegenstelling tot latere onderhoud van de douche, enorm verminderd tevoren. Dit voorkomt overmatige consumptie van reinigings- en verzorgingsproducten wat bespaart en minder schadelijk is voor het milieu. Gebruik geen schuurmiddelen, oplosmiddelen en ruwe schuursponsjes. Dit omdat zelfs de minste schade of barsten in het glas, zorgen voor nesteling van kalk en vuil. Wasmiddelen met een PH- gehalte lager dan 3 of hoger dan 10 beschadigen de profielen, scharnieren, handgrepen en glas coatings.



English

The following care instructions is recommended.

Regular maintenance and cleaning is important for your shower made of glass. It is useful to rinse immediately with plenty of cold water, after every shower. Stripping with a glass wiper prevents the adherence of lime. Spots thus have no chance. The profiles are sure to last, when they are wiped dry immediately with a soft cloth after showering. So is the time and energy, as opposed to later maintenance of the shower,

diminished enormously in advance. In addition, excessive consumption of cleaning and care products is reduced in this way. This saves money and protects the environment.

Do not use abrasives, solvents and harsh abrasive sponges. Because even the slightest damage and cracks in the glass, provide lime and dirt a real breeding ground in order to establish themselves here.

Detergents with a PH below 3 or above 10 damage profiles, hinges, handles and glass coatings.



Français

Les instructions d'entretien suivantes sont recommandées.

L'entretien régulier et le nettoyage sont importants pour votre douche en verre. Il est utile de se rincer immédiatement et abondamment avec de résidus d'eau froide après chaque douche. Décapage avec un essuie-glace de verre empêche l'adhérence de la chaux. Spots ont donc aucune chance. Les profils sont sûrs de durer, quand ils sont immédiatement séchés avec un chiffon doux après la douche. Donc, est le temps et de l'énergie, par opposition à l'entretien ultérieur de la douche, diminué énormément à l'avance. En outre, la consommation excessive de nettoyage et d'entretien est réduite de cette manière. Cela permet d'économiser de l'argent et protège l'environnement.

Ne pas utiliser de produits abrasifs, des solvants et des éponges abrasifs. Parce que même le moindre dommage et des fissures dans le verre fournissent la chaux et la saleté d'un véritable terreau pour se mettre en place ici. Détergents avec un PH inférieur à 3 ou supérieur à 10 profils de dommages, des charnières, des poignées et des revêtements en verre.

